

## ARCHITECTURAL SIGN SYSTEMS

## STANDARD SIGN SYSTEMS



### M²S² - Metal Modular Signs

Pages 5 - 8

This heavy duty anodized aluminum frame system provides everything from directories and room numbers to exterior post & panel signs. Suitable indoors and out.



### The Hospitality Collections

Pages 9 - 11

An upscale alternative to signing any facility type including hotels, medical facilities or education environments.



### The Stone Collection

Page 12

The Stone Collection highlights the natural granite backgrounds used to create room numbers and more.



### The Series S7000 Contour Frame System

Page 13

The Series S7000 offers a unique alternative in metal frames.



### The Series S1400 & S1500 Framed Sign Systems

Page 15

The Series S1400 & S1500 feature radius corner plastic and aluminum frames.



### The Series S2000

Page 14

The Series S2000 is a simple, changeable system that works with various types of message insert strip materials for ease in changing messages.



### Metal Plaques

Page 16

The most durable & long lasting alternative in interior and exterior dedication plaques, logos and more.



### The Series S1000 Acrylic System

Page 16

Designed to enhance the look of any property. Framed and metal mica header options available.



### The Oval Collection

Page 17

These oval molded acrylic backgrounds feature raised borders for a framed look without the cost.



### The Snap Plate System

Page 17

The Snap Plate provides an easily changeable system for frequently changed messages.

## SIGN SYSTEM OVERVIEW

Architectural sign systems incorporate a collection of sign types and materials with similar shapes and features for room numbers, area identification, and directories which allows you to provide a complete sign package with universal appeal. The sign types featured can be updated with your specific message and color. Custom sign types can also be manufactured from drawings or architect specifications.

### Standard Sign Types



### Additional Sign Types & Messages by Application

#### Health Care Environments

Administration  
Admitting/Discharge  
Exam Rooms  
Medical Office Suites  
Patient Room ID  
Attending Physician Designation  
Gift Shop

#### Hospitality Properties

Business Center  
Reception  
Concierge  
Stairwells  
Gift Shop  
Manager on Duty  
Ownership Signs  
Spa or Pool Rules/Hours  
Evacuation Route Maps  
Ice/Vending  
Housekeeping  
Lobby Logo  
Clearance  
Restaurant Hours

#### Libraries

Conference Rooms  
Operating Hours  
Study/Quiet Rooms  
Range Finders  
Library Directory  
Book Return  
Announcement Board

Youth Activity Programs  
Reference Areas  
Friends of the Library Locations  
Video Check Out  
Dedication Plaques  
Large Print Sections  
Code of Conduct

## M<sup>2</sup>S<sup>2</sup> - METAL MODULAR SIGN SYSTEMS OVERVIEW



New from Scott! Our new M<sup>2</sup>S<sup>2</sup> - metal modular sign system is constructed of heavy duty extruded aluminum featuring a natural anodized finish for interior or exterior projects. Create complete sign systems including changeable directories, ADA signs to comply and more.



### Snap Lock Frame System

Quickly and easily snap plates into place by pressing them on to the poly channel clips. Flatplates are ready to customize with surface applied vinyl copy or Channelplates accommodate a variety of changeable insert strip materials. See pages 6-7 for product details.

### AlumaFrame & Panel System (Square Corners)

The AlumaFrame System features a variety of signs in an attractive, low profile anodized aluminum frame featuring square corners. Create everything from wall mounted signs with a more permanent installation and double sided hanging, flag mount and post & panel signs using this versatile sign system. See page 8 for product details.



### AlumaFrame & Panel System (Round Corners)

These double sided signs offer a more permanent signage option. Hanging signs and post & panel signs are manufactured featuring rounded corners in an anodized aluminum frame. See page 8 for product details.



## M<sup>2</sup>S<sup>2</sup> SIGN TYPE OVERVIEW

Frame System	Directories	Directionals	ADA Signs	Double Sided Flag Mount	Double Sided Hanging	Post & Panel	Desktop
Sign Type							
Snap Lock	✓	✓	✓	✓	✓	✓	✓
AlumaFrame (Square Corners)	✓	✓	✓	✓	✓	✓	
AlumaFrame (Round Corners)					✓	✓	

Custom sizes, colors and sign configurations are available in all M<sup>2</sup>S<sup>2</sup> sign systems, call or fax (941) 351-1787 for quote.

## M<sup>2</sup>S<sup>2</sup> SNAP LOCK FRAME SYSTEM

### Lettering Options Glossary

Refer to Options A - F for Snap Lock Channelplates lettering options. Refer to Options G - H for Snap Lock Flatplates lettering options.

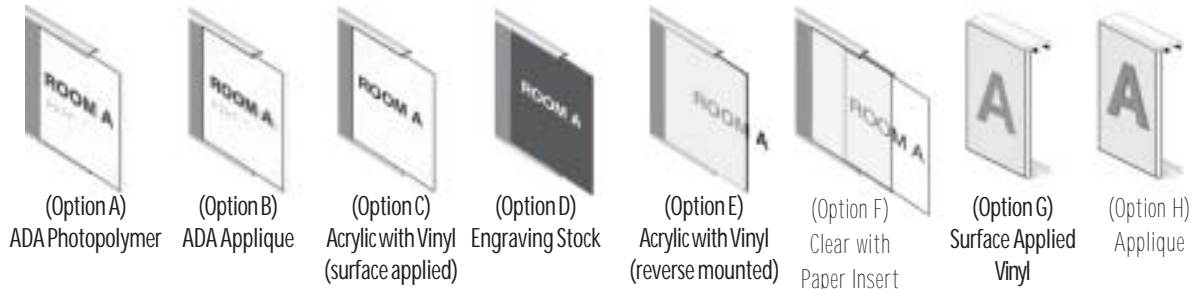

AlumaFrame panel lettering options include all of the above except Option F.

### M<sup>2</sup>S<sup>2</sup> Snap Lock Slider System

For signs up to 8" h we offer our Snap Lock Slider System. This sliding holder system utilizes flatplates and channelplates for a variety of lettering options including ADA signs to comply. Slide the holder end cap to load or unload the plates. To prevent vandalism, a special locking device is available.



Create ADA signs to comply w/photopolymer or ADA applique in channelplates.

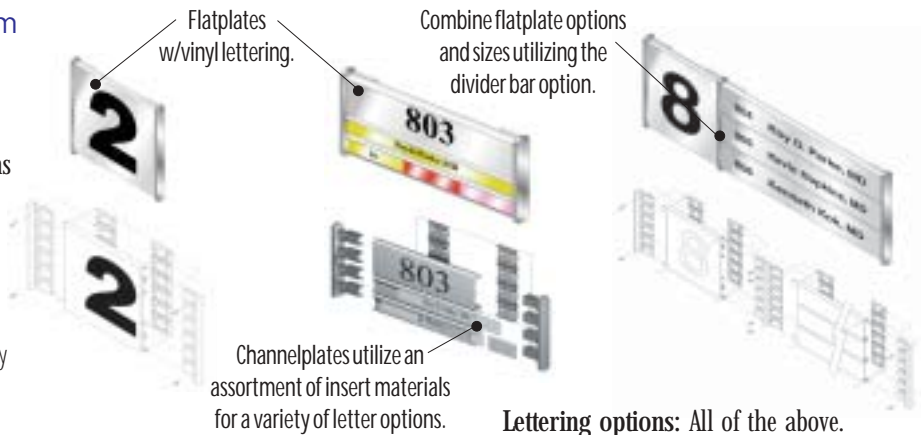

Lettering options: All of the above.

### M<sup>2</sup>S<sup>2</sup> Snap Lock Flatplate System

*Do it yourself with our flatplate signs and directories.*

For signs 8" h and above apply surface applied vinyl copy in-house or on site for updateable directories with upscale appeal. Flatplates also quickly and easily snap into place using the patented Channel Clip system.

Lettering options: G, H

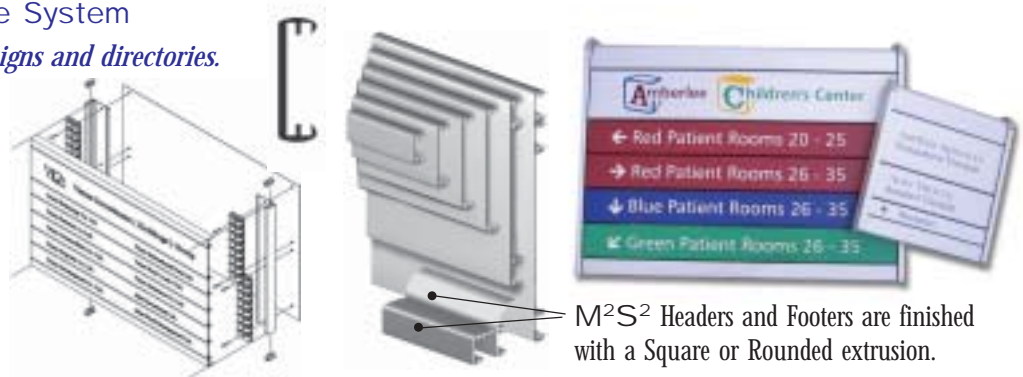

### M<sup>2</sup>S<sup>2</sup> Snap Lock Channelplate System

*Channelplate signs and directories utilize a variety of insert materials.*

For signs 8" h and above our channelplate system holds a variety of insert strip materials for an easily changeable and updateable directory system. Channelplates are far superior to traditional magnetic options and offer a secure, vandal resistant, yet changeable directory system.

Lettering options: A, B, C, D, E, F

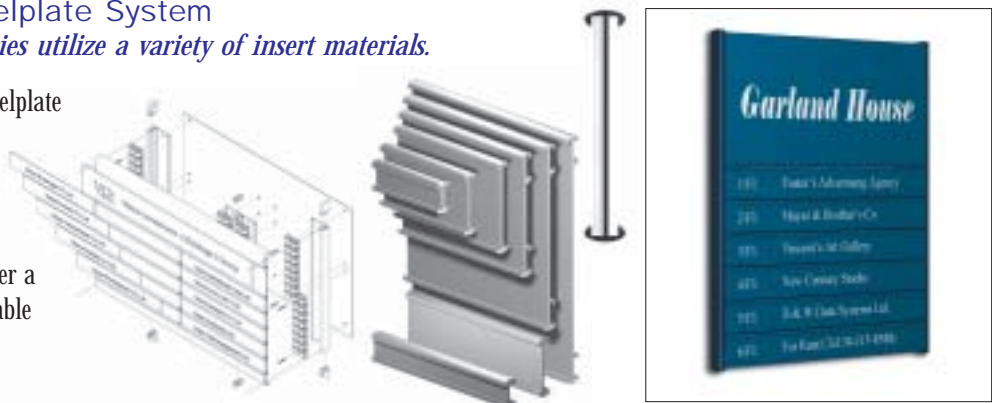

## M<sup>2</sup>S<sup>2</sup> DOUBLE SIDED SIGNS

### Snap Lock Double Sided Premium Post & Panel Signs



#### *New Post & Panel signs from Scott Signs*

New from Scott! These Post & Panel signs are economical and easy to assemble. Fabricated from all aluminum posts, flatplates, base cap and steel post bases. These signs feature a natural anodized aluminum finish and can be painted any standard or custom color. Flatplates can be quickly and easily updated on-site with surface applied vinyl copy. Round or squared top design standard.

Installation instructions are available upon request or available for download at [www.scottsigns.com](http://www.scottsigns.com).

### Snap Lock Double Sided Hanging Signs

*Complement our Snap Lock or AlumaFrame and Panel System with these attractive anodized metal framed Double Sided signs.*

Faceplates combine with Double Sided end caps for single or multi-line hanging signs up 12" h. Divider bars are also available for a variety of flatplate multi column layouts. **Lettering options: G, H**

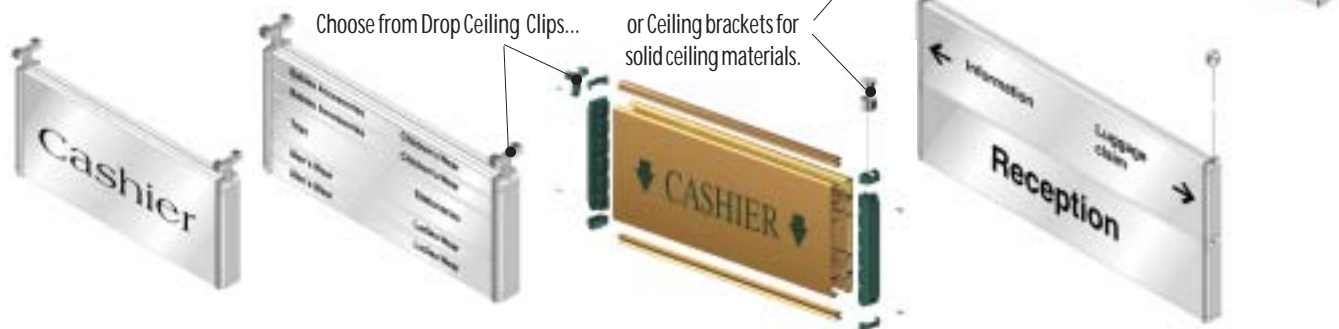

### Snap Lock Double Sided Flag Mount Signs

Flatplates and channelplates are available for Double Sided Flag mount signs. Flatplates feature an anodized aluminum finish and can be painted any standard or custom color. Refer to page 6 for Flatplate and Channelplate lettering options. **Standard End Cap Color: Grey**



End caps are also available painted any standard or custom color. Call for quote.



#### Desktop Signs

Desktop signs can be fabricated with flatplates & channelplates for a variety of lettering options and are easily changeable.

**Standard End Cap Color: Grey**



## M<sup>2</sup>S<sup>2</sup> - ALUMAFRAME SIGN SYSTEMS

For a more Permanent sign system option we offer M<sup>2</sup>S<sup>2</sup> AlumaFrames with panels featuring square corners.

This attractive anodized metal frame and plate system is economical, updateable and suitable for indoors or out. Create a variety of sign types including wall mount signs, room numbers, directionals, ceiling and flag mount signs and post & panel signs. Frame and panels can be painted any standard or custom color.

Lettering options: G, H



### AlumaFrame Wall Mount Signs - Square corners.

Panels are changeable for future design changes by removing 2 screws from the top of the frame as shown.



Plates are 1/16" thick anodized aluminum, 1/8" acrylic or photopolymer plates are also available for a variety of lettering options.

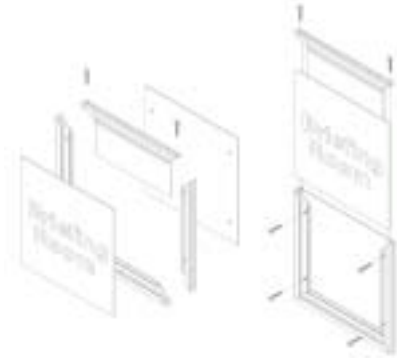

Lettering options:

A, B, C, D, E, G, H

### AlumaFrame Ceiling, Flag Mount and Post & Panel Signs Square corners.

Ceiling, flag mount and post & panel signs feature double sided construction in an anodized aluminum frame and panel. Heavy duty ceiling hangers and cable included.



Panel Lettering options: B, C, D, E, G, H

Additional plate materials are available. Call for quote.

### AlumaFrame Ceiling Mount and Post & Panel Signs Round corners.

AlumaFrame signs are constructed of an aluminum frame and frame connector with poly corners. Multiple frames and panels can be mounted to this post & panel system. Simply slide the frame connectors into the post channel for a quick and easy assembly. Hanging signs include heavy duty ceiling hangers and cable for solid ceiling installation.



Panel Lettering options: B, C, D, E, G, H

Additional plate materials are available. Call for quote.

# THE HOSPITALITY COLLECTION I - ARCHITECTURAL SIGN SYSTEM

The Hospitality Collection will complement any type of facility - hotels, office complexes, medical or educational facilities. Collection I, II and our new III edition features photopolymer on a decorative backer for ADA compliant options. Informational and directional signs feature subsurface mounted vinyl letters. For this complete upscale sign system just choose your size and color combination. For backgrounds, faceplates and letter/symbol colors refer to page 52 for standard paint colors. Custom colors also available.



The Hospitality Collection I & II feature a backer with a Roman Ogee edge.

## Guest Room Signage



3-1/2" x 4-1/2"  
Square Room Number

3-1/2" x 4-1/2"  
Oval Room Number

Radius  
No Smoking Symbol

Radius  
Accessible Symbol

8-1/2" x 11"  
Evacuation Route Map



## Informational Signs



4-7/8" x 8-7/8"  
Public Area  
No Smoking

4-7/8" x 8-7/8"  
Small Informational

12" x 12" Spa Rules

## ADA Area Identification



4-7/8" x 8-7/8"  
Stairs ID

4-7/8" x 10-7/8"  
Area/Room ID Large

4-7/8" x 8-7/8"  
Area/Room ID Small

4-7/8" x 10-7/8"  
Exterior Room ID Large



8-7/8" x 7-3/8"  
Restroom ID  
Area ID with Symbol

## Changeable Area ID



10-7/8" x 9-7/8"  
Meeting Room with Insert

## Front Desk Signs



12-7/8" x 12-7/8"  
Owner/Operator/MOD

7-5/8" x 14-7/8"  
Large Informational

## Directional Signs



4-7/8" x 14-7/8"  
1 - 2 Line Directional

7-5/8" x 14-7/8"  
2 - 4 Line Directional

5 - 10 Line Directionals are also available.

# HOSPITALITY COLLECTION II - DOME TOP SIGN SYSTEM

The Hospitality Collection II provides a variety of sign types in standard sizes that can be customized to your environment.



Choose your background and copy color from standard paint colors shown on page 52.

The Hospitality Collection I & II feature a backer with a Roman Ogee edge.

## Guest Room Signage



3-3/4" x 4-5/8"  
Dome Room Number



## Informational Signs



7-1/2" x 6-5/8"  
1 - 3 Line  
Informational



36" x 36"  
Pool Regulations  
18-3/16" x 16"  
Spa Regulations



2-1/16" x 2"  
No Smoking Symbol



4-9/16" x 6-5/8"  
1 - 2 Line Informational



4-1/8" x 4"  
Public Area No Smoking



2-1/16" x 2"  
Accessible Symbol



16" x 9"  
Evacuation Route Map

## Front Desk Signage



12-1/2" x 12-3/4"  
Owner/Operator/MOD



7-1/2" x 8-5/8"  
Large Informational

## Stairway Information



13" x 12"  
Stairwell Sign



9-3/4" x 11"  
In Case of Fire

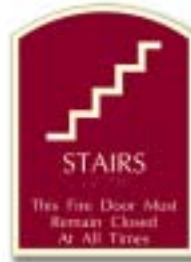

9" x 6-5/8"  
Stair ID

## ADA Area Identification



4-9/16" x 6-5/8"  
1 - 2 Line Area ID Small



7-1/4" x 12-5/8"  
1 - 2 Line Area ID Large

## Changeable Area ID



18-1/2" x 11-5/8"  
Large Insert Sign



9" x 6-5/8"  
Restroom ID

## Directionals



9" x 12-5/8"  
1 - 3 Line  
Directional



11-13/16" x 14-5/8"  
4 Line Directional

## ORDER INFO

- Please Specify
- Hospitality Collection II (Dome)
  - Sign Type
  - Letter Style & Size
  - Background Color; Letter and Backer Color (See Page 52)
  - Mounting Method

# THE HOSPITALITY COLLECTION III - ARCHITECTURAL SIGN SYSTEM



Choose from a variety of sign types and color combinations and provide your text message for a complete sign package.

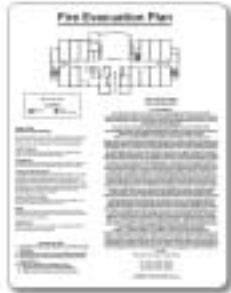

11" x 8-1/2"  
Evacuation Route Map

## Room Signage

4" x 6"  
Arch Room  
Number



The Hospitality Collection III features a backer with a full bevel edge.



1-5/8" x 6"  
Accessible Symbol



1-5/8" x 6"  
Non Smoking Symbol

## Front Desk Signage



7-7/8" x 7-7/8"  
Not Responsible



7-7/8" x 7-7/8"  
Owner /Operator



6" x 7-7/8"  
Manager On Duty

## ADA Area Identification



9-7/8" x 7-7/8"  
Restroom ID



7" x 7-7/8"  
Large Area ID



4" x 6"  
Small Area ID

## Informational Signage



7-7/8" x 7-7/8"  
In Case of Fire



7-7/8" x 7-7/8"  
Key Card Info



7-7/8" x 7-7/8"  
1-2 Line Area ID



7-7/8" x 7-7/8"  
Public Area No Smoking

## Changeable Area ID



16-1/2" x 9-1/2" - Large Insert Sign



12" x 9-1/2"  
Small Insert Sign

*Refer to Page 52 for standard painted background colors and copy colors.*

## Directionals



6" x 15-3/4" - 1 Line Directional  
8" x 15-3/4" - 2 Line Directional



10-3/4" x 15-3/4" - 3-4 Line Directional



19" x 15-3/4" - 7-10 Line Directional



13-1/2" x 15-3/4" - 5-6 Line Directional

## ORDER INFO

- Please Specify
- Hospitality Collection III
  - Sign Type
  - Letter Style & Size
  - Background Color, Letter and Border Color (See page 52)
  - Mounting Method

# THE STONE COLLECTION - ARCHITECTURAL SIGN SYSTEM

New from SCOTT! The Stone Collection features the upscale beauty of solid surface decorative backgrounds in a variety of designer colors to compliment the look of any facility.

## Premium Colors



## Standard Colors



Suggested letter colors shown with corresponding background color.



## Guest Room Signage



4" x 5-1/2"  
Room Number



4-1/4" x 9"  
Large Area ID

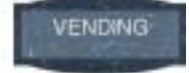

3-1/4" x 7"  
Small Area ID

## Front Desk Signage



6-1/2" x 7-1/2"  
Owner/Operator



6-1/2" x 9"  
Manager on Duty

## Changeable Area ID



11" x 10-1/2"  
Small Meeting Room Insert



18" x 10-1/2"  
Large Meeting Room Insert

## Directionals



4-1/2" x 9-1/2"  
1-2 Line Directional



6-1/2" x 9-1/2" 3-4 Line Directional  
8-1/2" x 9-1/2" 5-6 Line Directional  
10-1/2" x 9-1/2" 7-8 Line Directional  
12-1/2" x 9-1/2" 9-10 Line Directional

## ADA Area Identification

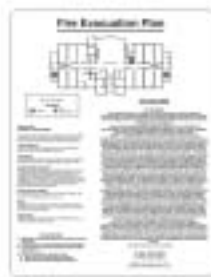

11" x 8-1/2"  
Acrylic Evacuation Route Map



10" x 7"  
Floor ID



10" x 7"  
Restroom ID

## Stairway Information



12-1/2" x 9-1/2"  
Stairwell Sign



10" x 7"  
In Case of Fire



10" x 7"  
Elevator Evac Map

## Informational Signs

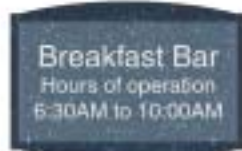

6-1/2" x 9-1/2"  
Breakfast Hours



4-1/2" x 5-1/2"  
No Smoking ID



4-1/2" x 5-1/2"  
Small Informational



6-1/2" x 7-1/2"  
Medium Informational



15-5/8" x 18-1/2" Fitness Center  
36" x 41-1/2" Pool Rules 13" x 15" Spa Rules

SIGN SYSTEMS  
ADA SIGN SOLUTIONS  
DIMENSIONAL LETTERS  
LOGOS & GRAPHICS  
ILLUMINATED SIGNS  
SIGN SUPPLIES  
ORDER INFO

# SERIES S7000 - CONTOUR ALUMINUM FRAME SYSTEM

## Contour Aluminum Frames

The Series S7000 offers a unique alternative in metal frames. Create ADA compliant room numbers, directories, informational signs and changeable units for menus, schedules and more. Hanging directories, free standing pylon directories and table top units are also available. Mechanical mounting option must be specified at time of order. Paper inserts are not included.

**Standard Sizes:** (Height x Width)      **Standard Frame Colors:** Satin Silver or Black      **End Cap Colors:** Black or Grey

Standard sizes shown are Height x Width. Contour frames shown have a horizontal curve (left to right) and are not exact measurements. The 2-1/4" x 10" has a vertical curve which goes top to bottom. Additional sizes are also available.

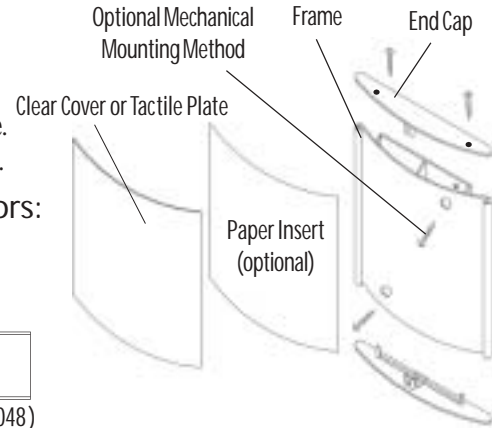
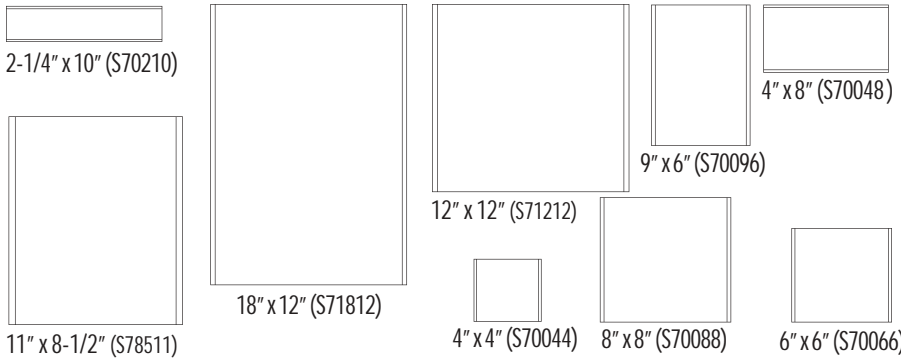

### ORDER INFO

Please Specify . . . Series S7000

- Size (H x W)
- Face Color
- Copy Color
- With or Without Braille
- Mounting Method
- Frame Color
- Letter Style
- Insert Material

### Insert/Letter Options:



**Photopolymer Insert - Solid Color**  
Incorporate custom graphics, logos, ADA compliant raised letters and braille with our versatile photopolymer material.



**Clear Photopolymer Insert - Digital Print Background**  
Clear photopolymer can be used to create ADA compliant raised letters, graphics and braille combined with full color digital print backgrounds or printed paper.



**Clear Photopolymer Insert - Painted Background with Window**  
Combine ADA compliance and the changeability of paper inserts with a clear window to display updateable messages.

## S7000 Towers

Call for standard sizes or custom quote.



## S7000 - Hanging Signs



Additional Sizes Available			
Frame Width	Insert Size	Frame Width	Insert Size
1.18"	1.02"	19.68"	19.59"
1.57"	1.42"	22.08"	22"
3.14"	3.05"	23.62"	23.52"
4.72"	4.61"	28.08"	28"
8.46"	8.31"	32.08"	32"
11.10"	11"	36.05"	36"
14.16"	14"	40"	40"
15.74"	15.61"	44"	44"
16.7"	16.54"	48"	48"
17.15"	17"		

Extrusions shown above in stock silver or black finish. 14" frames and above utilize silver or black metal end caps.



3 Day Quick Ship applies to standard size frames with clear lenses, no holes drilled in quantities of 50 or less.

## S7000 - Stand-up/Table Top Signs

Create free standing table top units with Boomerang and Kangaroo style end caps.

Boomerang End Cap sizes: 2-1/4", 4", 6", 8-1/2"

Kangaroo End Cap sizes: 4", 6", 8-1/2"

Frame with Boomerang End Caps (Black or Silver)

Frame with Kangaroo End Cap (Silver only)



Double and single sided wall mounted signs are also available with 4", 6", 8", 10" and 12" sign frames.



# SERIES S2000 - CHANGEABLE INSERT SIGNS

*The Series S2000 provides you with easily changed messages while maintaining ADA compliance. Inserts slide into channels behind a clear window for quick updates or personalization.*

A simple, changeable system that works with various types of message insert strip materials for ease in changing messages. SCOTT provides this series with a variety of lettering alternatives: vinyl or dimensional lettering, including ADA compliant options. Choose from many standard sizes and colors, including custom colors.

*The Series S2000 room numbers feature a changeable window for a polaroid or 3"x 5" photo.*

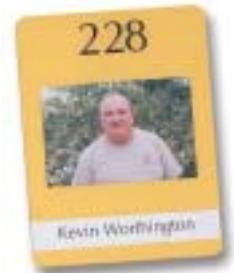

## ORDER INFO

Please Specify . . . Series S2000

- Sign Type (2100 or 2300)
- # of Windows
- Square or Radius Corners
- Background Color
- Mounting Method
- Size (H x W)
- Window Size
- Copy Color
- With or Without Braille



*The Series S2000 is great for creating your own paper inserts\*.*

### Series S2100

Frameless 2 ply acrylic system with tactile lettering on header. Vinyl Letters & Graphics are also available on header.

Applied Raised Letters & Braille



S230606 - Photopolymer Header

### Series S2300

Frameless 2 ply acrylic with photopolymer header. Refer to page 52 for all standard photopolymer background colors, copy/graphic colors.

Integrated Raised Letters & Braille



S210606 - Acrylic Header (paper insert)

## Series S2000 Standard Sizes:

6" x 6" (1" windows)	6" X 6" (3/4" windows)	8" x 8" (1" windows)	10" x 10" (1.25" windows)	12" x 12" (1.50" windows)
S210601	S210675	S210808	S211010	S211212
S230601	S230675	S2310808	S231010	S231212
4" x 8" (1" window)	8" x 4" (.75" windows)	12" x 6" (.75 windows)	12" x 6" (1" windows)	11.5" x 9" (8.5" x 11" windows)
S210408	S210804	S211267	S211261	S211109
S230408	S230804	S231267	S231261	
4" x 4" (.75" windows)	2" x 10" (1" windows)			
S210404	S210210			
S230404				

## Room Numbers\*\*

11-7/8" x 11-7/8"	6" x 6"
S611212A10, S621212A10	S6166A4 S6266A4
11-7/8" x 5-7/8"	6" x 6"
S61126A8, S62126A8	S6166A5 S6266A5
11-7/8" x 5-7/8"	4" x 4"
S61126A9, S62126A9	S6144A2 S6244A2
9-1/8" x 6-1/8"	4" x 4"
S6196A6, S6296A6	S6144A3 S6244A3

All units shown are standard with the maximum amount of windows available. All sizes may be specified with fewer windows at no additional cost. When deleting windows, header increases in size. Custom shapes, sizes and configurations are also available. \* Note: Inserts are not included with the S2000 unless ordered separately. \*\*S2000 Room Numbers shown above are not available with a photopolymer header standard. Room Numbers are available with or without frames.

## SERIES S1400 PLASTIC & S1500 METAL FRAMED SIGNS

*Framed architectural sign systems are easy to update and provide a finished appearance for any environment.*

Framed architectural sign systems offer the ease of changeability or an upscale look to ordinary signage. The S1400 and S1500 Series feature radius corners with 1/2" depth and 1/8" wall thickness. Snap in or magnetically mounted plates are available with applied tactile or vinyl lettering. Photopolymer and engraved plates are also available.

### SERIES S1400 Plastic Frames & Plates

Plastic frames and plates are designed for a quality, changeable interior sign system.

Frame and Plate molded colors:

Almond, Brown, Medium Grey, Black - Plates also available in Clear non-glare, painted.  
The inside plate easily snaps in and out of the outside frame with an inside radius of 5/16".  
Frames have holes for mechanical mounting, or can utilize VHB tape.



### ORDER INFO

Please Specify . . . Series S1400 or S1500

- Plastic or Aluminum Frame
- Frame Color/Finish
- Letter Style
- Tactile or Vinyl Copy
- With or without Braille
- Mounting Method
- Plate Color
- Copy Color

Letter Options for Series S1400 or S1500 plates:

Tactile, Raised lettering with Brailldots.

Vinyl - Surface mounted on solid color or subsurface mounted on clear non-glare acrylic.



### SERIES S1500 Aluminum Frames & Plates

Aluminum frames provide upscale style with a changeable magnetic system or permanently mounted plates.

Aluminum Frame Finishes:

Anodized Polished Gold and Silver.

Frames feature a changeable magnetic system or permanently mounted plates.

Frames feature an inside radius of 3/8".

Background Plates - are cut 1/8" thick Black, or Painted Clear non-glare acrylic.



S156603

### SERIES S1400 & S1500 STANDARD FRAME SIZES

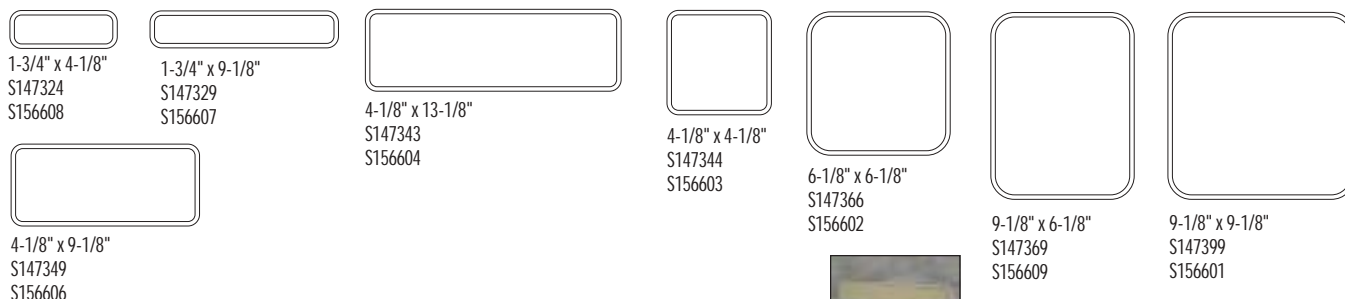

#### Plastic Desk Bar (S147029)

Perfect for office environments as a name plate holder or counter sign.  
(1" thick x 1-3/4" x 9-1/8")



**Plastic Base (S147500)** Converts frame S147329 into a desk or counter unit as shown.

### PHOTOPOLYMER PLATES

The Series S1400 & S1500 are also available with Photopolymer plates. This versatile material which includes raised letters, graphics and braille can also be used inside our plastic or metal frames. Plates can be permanently mounted with double sided tape or magnetically mounted for changeability.

*Refer to page 52 for all standard photopolymer background colors and copy/graphic colors.*



## SERIES S1000

## ARCHITECTURAL SIGN SYSTEMS

*Acrylic signs with or without an upscale metal mica header.*

The Series S1000 Architectural Sign System will complement and enhance the look of any property. Available framed or unframed.

## ORDER INFO

Please Specify . . . Series S1000

- Size
- Letter Style
- Face Colors
- Copy Color
- Tactile or Vinyl Copy
- With or Without a Frame
- With or Without a Header
- Header Color
- With or Without Braille
- Mounting Method

## Standard Sizes:

4" x 4"   6" x 6"   8" x 8" MOD  
 8" x 8"   10" x 10" (Frameless only)  
 12" x 12"

## Frame Colors:

Black  
 Medium Grey  
 Almond  
 Brown  
 Pewter Grey

## Metal Mica Header Colors:



## Letter Options:

Vinyl  
 Tactile, Raised lettering with Brailldots

**S1200M & Manager On Duty**

Framed unit with a metal mica header and changeable insert plate

**S1100M** - Frameless unit with a mica header**S1100W** - Frameless unit without a mica header**S1200W** - Framed unit without a mica header

## MEETING &amp; CONFERENCE ROOM SIGNS



Identify in use or vacant rooms with an easily changeable slider. Specify square or radius corners. \*Note: 6" x 6" signs will not accommodate "CONFERENCE ROOM" in ADA compliant raised copy and Braille.

## METAL PLAQUES

## ARCHITECTURAL SIGN SYSTEMS

*The most durable & long lasting alternative in interior and exterior dedication plaques, logos and more.*

Metal plaques offer the ultimate in durability and style. Create dedications, award & recognition, monument signs and logos with long lasting appeal. Choose from Bronze, Brass, Stainless Steel and Aluminum.

## Surface Finishes Available:

Satin or Polished Raised Copy & Backgrounds  
 Painted Recessed Copy & Backgrounds

## Edge Treatment:

Straight Edge or Half Bevel Edge.  
 Refer to current price book for additional edge treatments.

Letter Styles: Any standard letter style shown on page 29. Custom letter styles also available.

Rosettes: Decorative covers for bronze and aluminum plaques used to cover screw heads.



Specialty finishes also available. Call for quote.

## THE OVAL COLLECTION

### Break the Square Routine!

For room numbers, area identification and small directional signs the Oval Collection features oval backgrounds with raised borders. Backgrounds are molded acrylic with raised borders.

#### ORDER INFO

Please Specify . . . Oval Collection

- Size
- Border Color
- Copy Color
- Mounting Method
- Face Color
- Letter Style
- With or without Braille

Standard Sizes:  
 2-7/8" x 4-1/2"    4-1/2" x 6-1/2"  
 6-1/2" x 9-1/2"    8" x 12"

Standard Background Colors:  
 Black, Plum and Clear non-glare Painted

Standard Border Colors:  
 Polished or Brushed Gold or Silver

Standard Tactile Letter Styles:  
 Caslon, HM

## THE SNAP PLATE® SYSTEM

### Changeable plates mounted within frames. Great for permanent or frequently changed signage.

The 3 part Snap Plate System is vandal resistant yet easily changed. It consists of a frame with a protruding ledge on the inside dimension which houses an insert plate and clear snap plate. Paper inserts are easily enclosed and can be frequently changed, if desired. Vinyl letters and logos are also a great alternative for applying messages. Standard color frames and snap plates without lettering are available to ship in one day.

Frame & Insert Plate Colors:



Standard Sizes: 2" x 10", 4" x 4", 4" x 8", 6" x 6", 6" x 12", 8" x 8", 10" x 10", 8-1/2" x 11"



#### 8.5" X 11" Snap Plate

This unique frame accepts standard size 8.5" x 11" paper inserts for frequently changed or updated signs. Actual frame size 8.75" x 11.25". Standard frame thickness - 5/8" or 3/8" frame available upon request.

Snap Plate Colors: Black, White, Almond, Grey, Clear non-glare, and Painted.

#### Lettering options:

##### Tactile Lettering -

Raised letters and braille are applied to the Snap Plate for ADA compliance. Combining tactile letters with changeable paper inserts is great for meeting room applications. Photopolymer headers can also be applied.



Refer to page 52 for all standard photopolymer background colors and copy/graphic colors.

##### Vinyl -

Reverse cut or regular cut vinyl mounted to the clear non-glare snap plate allows the color of the insert to show through and can be combined with paper inserts.



#### Pin Mounting Option -

Great for workstations and temporary signage applications.

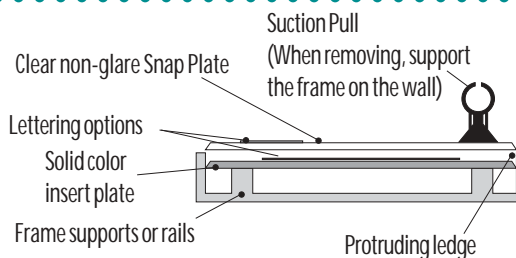

#### Paper Insert Sheets -

Paper can be placed between the insert plate and the Snap Plate. Insert sheets may be computer generated or handwritten for frequently changed signing applications.

#### 2" x 10" Inserts -

Perforated papers are also available to fit our 2" x 10" unit - Perfect for cubicles or modular work stations. Template included.

#### ORDER INFO

- Please Specify . . .
- Frame Color
  - Snap Plate Color
  - With or Without Lettering
  - With or Without Braille
  - Mounting Method
  - Snap Plate
  - Insert Color
  - Size

# TABBEE® CHANGEABLE MESSAGE BOARDS

## GENERAL INFORMATION

All interior models are available with grooved boards for changeable Tabbee® letters.

All Exterior models are available with vinyl for changeable Tabbee® letters.

**Standard Interior felt color:** Black

Additional colors available at additional cost:  
Burgundy Blue Green Grey

**Standard Exterior vinyl color:** Black

Additional colors available at additional cost:  
Burgundy Blue Hunter Green Grey

**Standard frame color:** Satin Anodized Aluminum

Additional colors available at additional cost:  
Gold Anodized, Black Anodized, Grey Powdercoat,  
Burgundy Powdercoat and Bronze Powdercoat.  
(Note - custom colors and sizes are nonreturnable.)

*All standard sizes shown are  
outside dimensions including the frame.  
Custom sizes are also available.*

## ORDER INFO

Please Specify . . .

- Model Type
- Size (W x H)
- Panel Material
- Panel Color
- Frame/Case Color/Finish



## Open Faced Bulletin Boards (EA)

Standard Features:

- Interior Use Only.
- Open face - no acrylic front.
- Frame - 1" wide, standard Satin Anodized Aluminum, 1/2" deep.
- Wall hanging brackets provided.
- Black felt letterboard surface.

Standard Sizes (W x H):

18" x 24"      24" x 36"      30" x 36"  
48" x 36"      72" x 48"

For Open Faced Bulletin Boards with Cork or Marker Board refer to page 19.

## Slim Style Enclosed Letterboard (GD)



Side View

Standard Sizes (W x H):

12" x 18"      18" x 24"      24" x 36"  
30" x 36"      36" x 36"

Standard Features:

- Interior Use Only.
- Shatterproof, clear acrylic door with solid disc tumbler side lock. (Two keys included)
- Satin Anodized Aluminum Frame.
- Wall hanging brackets provided.
- Black felt letterboard surface.
- Also available with Cork Boards.

## Enclosed Letterboards (AD)

Standard Features:

- Interior or Exterior Use.
- Shatter-resistant, acrylic windows.
- Black felt letterboard interior.
- Heavy anodized aluminum case, 1" wide main frame, 2" deep
- Frame - standard Satin Anodized aluminum frame.
- Exterior letterboards feature weather-resistant aluminum backing with silicone sealant and Black vinyl letterboard interior is standard.
- Also available with Cork Board

Standard Sizes (W x H):

18" x 24" (1 Door)      24" x 36" (1 Door)  
42" x 32" (2Doors)      48" x 36" (2 Doors)  
60" x 36" (2 Doors)      72" x 36" (3 Doors)  
72" x 48" (3 Doors)



## Adjustable Pedestal Boards (AS1)



- 18" x 14" or 20" x 15" Single or Double Faced.
- Black felt letterboard surface.
- Anodized Aluminum frame and post with black base only.
- Stand Adjusts Between 36" - 66"
- Easy Open construction.
- For Indoor Use only.
- Note: Double faced letterboards are available with a non-adjustable 36" pedestal only.



Custom sizes are also available. For a free quote e-mail: [quote@scottsigns.com](mailto:quote@scottsigns.com) or fax (941) 351-1787.

# TABBEE® CHANGEABLE MESSAGE BOARDS

## 3-In-1 Combo Boards

- Three-in-one combo boards offer the most versatility.
- Features markerboard, corkboard, and letterboard all in one board.
- Corkboard and letterboard insert easily into frame.
- Satin Anodized Aluminum Frame.
- Lockable door on full length piano hinge.
- Shatter resistant acrylic window.
- 24" x 36" (W x H)

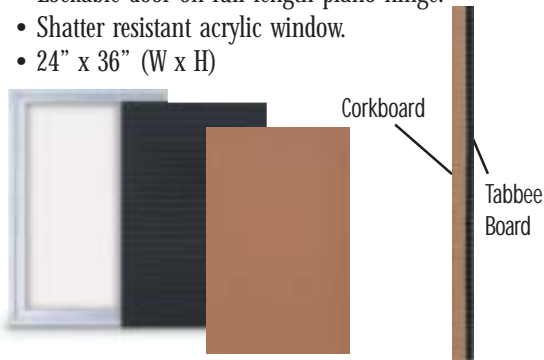

## Framed Corkboards & Markerboards

- Satin Anodized Aluminum Frame.
- Self-sealing natural cork or white, non-magnetic melamine surface.
- Factory installed hangers for mounting.
- Markerboards feature marker tray.



### Standard Sizes (W x H):

36" x 12"    24" x 18"    36" x 24"  
48" x 36"    60" x 36"    72" x 48"

## Tabbee® Letters



**Standard Molded Colors:**  
Black & White

**Two Tone/Hot-Stamped Colors:** Polished or Brushed, Silver and Gold.

**Please note:** Tabbee fonts are sold as complete letter sets only, as shown on page 34.

# CHANGEABLE MESSAGE SIGNS



**M²S² Metal Modular**  
Easily update vinyl letters applied to flatplates or choose from a variety of insert materials for use with our channelplates option. Refer to page 6.



**The Series S2000**  
A simple, changeable system that uses a variety of message insert strip options for ease in changing messages. Refer to page 14.



**The Series S7000**  
These signs are also available with a clear window to display custom messages generated directly from your desktop. Refer to page 13.



**The Snap Plate System**  
Change messages, agendas, and more in a snap. Remove the clear face plate and display your message quickly and easily. Refer to page 17.

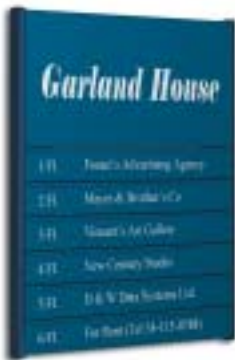

*New M²S² Metal Modular Directories are ready to customize. Choose Flatplates for vinyl letter applications or channelplates for a variety of insert materials.*

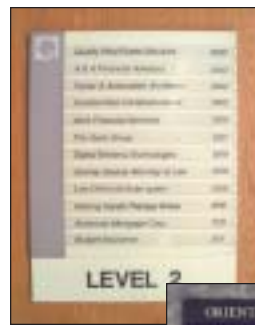

*Magnetically mount nameplates for an economical, changeable sign.*

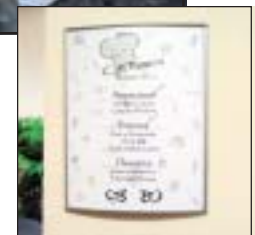

*Our Snap Plate & S7000 systems are in stock and ready to ship and customize.*

## DIRECTORIES

### Custom Directories

Scott offers a variety of Directory options. Call a Scott Representative to discuss your project needs or fax your specifications for a free quote.



Custom Acrylic Directory with Stand-offs - Type DIR 1

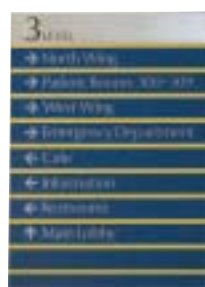

Decorative Bar Header Directory - Type DIR 2



In/Out Personnel Directory - Type DIR 3



M<sup>2</sup>S<sup>2</sup> Metal Modular Directory - Type DIR 4

### S7000 Directories



72" x 24"

Directory options are also shown with most Architectural Sign Systems. Refer to pages 5-20.



Hospitality Collection Directory - Pages 9-11



Series S1000 Directory options are featured on Page 16

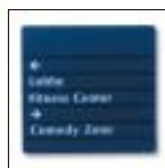

### Wall Mounted S7000 Directories



Stack individual frames for easily changed directories. Utilize designer paper inserts for unique backgrounds.

## CUSTOM FABRICATION

Send us drawings with your designs or that of an existing sign system. Scott can manufacture from a wide variety of materials.



## ENGRAVING COLOR SELECTION

SCOTT offers a range of colors and finishes, including sophisticated, natural looking metals from the ROWMARK® engraving and routing material selection. These materials can also be used to produce stunning background panels for plastic and vinyl lettering and graphics. Scott engraved products are great for a low cost sign alternative. For a wider color selection utilize our Matte/Clear Ultra-Matte material for painted color options.



*Engraved signs can be the most economical signs available. They are long lasting and offer a wide variety of color options.*



Pin and Magnetic Fasteners Shown

## Engraved Badges

Scott offers an economical line of badges as well as custom badges that will create an atmosphere of professionalism for all businesses and/or functions. Choose from any of the standard options shown.



## Engraved Logo Badges



## Premium Logo Badges

## Custom Metal Badges



**Engraving** Produce background panels and architectural signs from the following 1/16" thick materials.

### Laser Max - Mattes (Interior or Exterior Use)



### The Metals - NoMark (Interior Use Only)

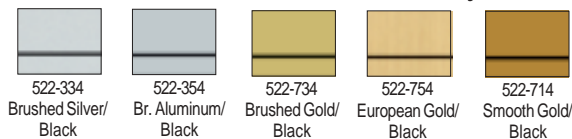

## Engraved Sign Holders



### Acrylic Counter Base

ENGJRP100

Excellent for a frameless 1/16" thick sign.

Available in clear or black, 2" wide by 8" or 10" in length.



### Pedestal Stands ENGJR48

Flush Wall Mounts ENGJR58

Perfect for 1/16" thick wall or desk signs. Available in Gold or Silver, 2" wide by 8", 10" or 12" in length.



### Wall Mounted Sign Holder ENGJR38

Available in Polished Gold or Silver, 2-1/2" wide by 2" or 4" in length.

### Ultra-Matte (Interior or Exterior Use)

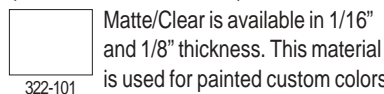

### DuraDigital™ (Interior or Exterior Use)

Create your own custom engraving stock! Full color photo quality images are embedded into a PETG background to create your own custom engraving stock. No minimum material requirements apply. Get your free quote today. Standard Thickness: 1/16", 1/8", 1/4"

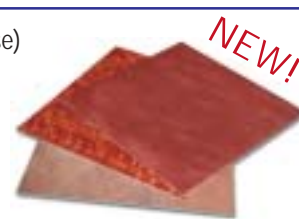

## ORDER INFO

Please Specify . . .

- Engraving Material
- Reverse or Regular Engraved
- Letter Style (See Page 29)
- Square, Notched or Radius Corners
- Size (H x W) • Plain Back or VHB
- Mounting Method

For backpainted ADA compliant options refer to page 24 for exterior ADA applique options refer to page 25.